

CARE +
PROTECT

CARE +
PROTECT

Professional care for your home

The best for your home appliances

Universal accessories and
cleaning products for the home

WASHING

COOKING

COOLING

VACUUMING

IRONING

COFFEE



CATALOGUE - 49041129

www.careplusprotect.com

RECOMMENDED BY

CANDY



ROSIÈRES

Baumatic

ZEROWATT

RECOMMENDED BY

CANDY



ROSIÈRES

Baumatic

ZEROWATT



Professional care for your home

The best for your home appliances

Care+Protect's mission is summed up in its name and payoff line. **Professional products for the care, maintenance and protection of your home and appliances.**

Regular maintenance of your household appliances is fundamental and only by using professional products can you extend their life span and effectiveness over time.

Thanks to the experience of the Candy Group, a group that has always been focused on manufacturing home appliances and which Care+Protect forms a part of, a complete range of products has been developed to provide excellent results.

Experience, professionalism and the constant search for **innovation** make Care+Protect a highly specialised range, **recommended by major manufacturers of home appliances.**



RECOMMENDED BY

CANDY



ROSIÈRES ©

Baumatic

ZEROWATT

This catalogue is **divided into 6 sections**, to help you easily find the products dedicated to each category of home appliances.

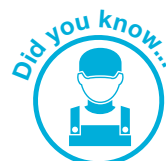

In the “Did you know...” box in each section, you will find advice and recommendations from our technicians, who are specialists in home appliances and always know how best to care for them.

In addition, we **always want to be there for our customers** and offer them a range that suits their needs. In the “Just for you” box, you will find what customers love most about our products, real benefits that make home living even easier.



To learn even more about our individual products and how to get the most out of them, **watch our videos on our dedicated Care+Protect YouTube channel.**

 [/channel Care + Protect](https://www.youtube.com/channel/Care+Protect)



Professional care for your home

Universal accessories and cleaning products for the home

WASHING		5
<ul style="list-style-type: none"> Care and maintenance Laundry perfumes Detergents and care for dishwashers Stacking kits and accessories for dryers Inlets and hoses for washing machines and dishwashers 		6 10 12 14 18
COOKING		23
<ul style="list-style-type: none"> Detergents and care for kitchen surfaces Hood filters Accessories 		24 26 34
COOLING		37
<ul style="list-style-type: none"> Detergents and odour absorbers for fridges and freezers 		38
VACUUMING		41
<ul style="list-style-type: none"> Detergents, deodorants and accessories for vacuum cleaners 		42
IRONING		45
<ul style="list-style-type: none"> Care and maintenance 		46
COFFEE		49
<ul style="list-style-type: none"> Care and maintenance 		50



Washing



A wide range of accessories, descalers, hygienic cleaners and fragrances for washing machines, dishwashers and dryers.



3-IN-1 LIMESCALE REMOVER - DEGREASER - HYGIENIC CLEANER

Effectively combines **descaling, degreasing and sanitising into a single product**. Removes limescale build-up, deeply cleans and removes mould and bad odours, extending appliance life and reducing energy consumption. Monthly treatment is recommended. Available in two pack sizes with 12 or 4 single-use sachets.



Removes limescale



Degreases and eliminates odours



Extends appliance life

In the washing machine



Pour a sachet directly into the drum and run an empty cycle (without laundry) at 60 degrees temperature, without a prewash.

In the dishwasher



Pour half the sachet into the bottom of the dishwasher and the other half into the detergent dispenser and run an empty cycle (without dishes) at maximum temperature, without a prewash.



A practical and effective product, the **ideal solution** to protect and keep your appliances hygienic.

Did you know...



- Limescale is formed by water with high levels of calcium, magnesium and other minerals that form deposits **from the first day of use on heating elements and internal parts** of an appliance.
- Deposits cause overheating of the heating element, affecting normal operation. Removing calcium deposits helps to **keep consumption down and maintain appliance performance, extending its life**. Monthly descaling treatment is recommended.

Just for you



It removes bad odours, grease and mould that hide in the most inner parts of the appliance.
Reduced energy consumption.
Care and hygiene for the whole family.



MAGNETIC DESCALER

From the first day of use, it helps to **prevent the formation of damaging limescale**, keeping heating elements cleaner and extending the service life of your appliance. It softens hard water, leading to reduced consumption of both energy and detergents, improving washing performance.



Prevents limescale



Reduces energy consumption



Extends appliance life

For washing machines



For dishwashers

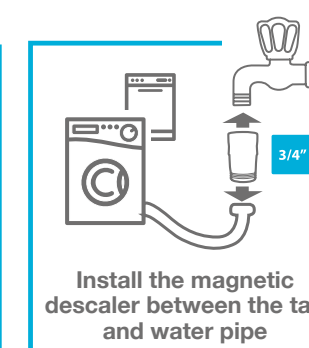

Install the magnetic descaler between the tap and water pipe



Did you know...



- The magnetic descaler **prevents** limescale from forming on internal parts of the appliance.
- It uses a **powerful magnetic field** to force the water to follow a certain path, breaking down the molecules of hard salts, transforming calcite into aragonite, which remains suspended and is easily dragged by the current of water out of the appliance.
- Use of the magnetic descaler is recommended for areas with very hard water. Its use ensures that heating elements and internal parts are protected from day one, **maintaining performance and low consumption**.

Just for you



Your washing will be softer and fabrics will be protected. Dishes will be cleaner and brighter.
Reduced energy consumption.
Quick and easy to install.
Completely safe for the environment.

CDP1012 35601768 EAN 8016361934573 12 sachets x50gr



CDP1004 35601769 EAN 8016361934580 4 sachets x50gr



WMD1001W 35601927 EAN 8016361957794



Maximum efficiency at 60°C

HYGIENIC CLEANER TABLETS FOR WASHING MACHINES

The tablets have been formulated to **deep clean internal parts** of the washing machine (pipes, drum, seals, door glass...). **Hygienically clean, degrease and remove washing powder and fabric conditioner residues.** Pleasant **lavender** fragrance. **Resealable packs** to maintain the quality of the tablets. Monthly treatment is recommended.



Removes washing and detergent residues



Hygienically cleans and removes odours



Safe touch - Protective water-soluble film wrapper

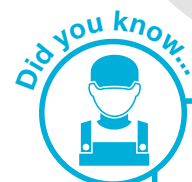

Over time, residues from detergents can cause dirty deposits even on seals and the most hidden places. The enzyme formulation ensures deep cleaning of the washing machine.



Ideal for sanitising the drum after washing clothes full of dust and pet hair.

CDT1006 35601789 EAN 8016361935419 6 TABS x 20g



Maximum efficiency at 60°C

HYGIENIC CLEANER TABLETS FOR DISHWASHERS

Ideal for **deep cleaning the filter** and all the internal parts of the dishwasher (pipes, tub, spray arms...). **Degrease, sanitise and eliminate washing residues.** Fresh **lemon** fragrance. **Resealable packs** to maintain the quality of the tablets. Monthly treatment is recommended.



Degreases and removes washing residues



Hygienically cleans and removes odours



Safe touch - Protective water-soluble film wrapper

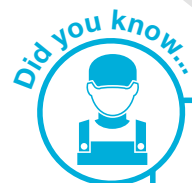

Washing residues reduce the performance of the dishwasher, especially when in the vicinity of the filter. Monthly use of a professional hygienic cleaner provides deep cleaning of all internal parts of the appliance.



Ideal for the safety of the whole family and for cleaning even the crockery/ cups and plates.

CDT2006 35601799 EAN 8016361938847 6 TABS x 20g



WMD1010-K 35602105 EAN 8016361975774

WASHING MACHINE CARE KIT

The kit ensures deep cleaning of the drum, pipes, plastic seals and all internal parts of the washing machine and extended protection from limescale, reducing energy consumption and extending the life of the appliance. It includes 1 magnetic descaler, 1 monthly 3-in-1 descaling powder treatment and 6 hygienic cleaner tablets. **Choose the kit to save money.**



Prevents and removes limescale



Hygienically cleans and neutralises odours



Degreases and removes washing residues



WMD1020-K 35602104 EAN 8016361975767

DISHWASHER CARE KIT

The kit ensures deep cleaning of the filter and all internal parts of the dishwasher and extended protection from limescale, reducing energy consumption and extending the life of the appliance. It includes 1 magnetic descaler, 1 monthly 3-in-1 descaling powder treatment and 6 hygienic cleaner tablets. **Choose the kit to save money.**



Prevents and removes limescale



Hygienically cleans and neutralises odours



Degreases and removes washing residues



WMD1002-K 35602103 EAN 8016361975750

DESCALING KIT FOR WASHING MACHINES AND DISHWASHERS

The kit ensures extended protection from limescale, reducing energy consumption and extending the life of your washing machine and dishwasher. It includes 1 magnetic descaler and 2 monthly 3-in-1 descaling powder treatments. **Choose the kit to save money.**



Prevents and removes limescale



Reduces energy consumption



Prolongs appliance life



100% PURE ESSENCE CONCENTRATED LAUNDRY PERFUME

The fragrances bond to the fibers, giving fabrics a simple touch of style. Suitable for **all types of fabrics, colours and washing programmes**. Also suitable for sportswear. Thanks to their special active formula, clothes remain fragrant for up to 5 weeks. Intense fragrance even after tumble drying. **Do not stain.**



Suitable for all types of fabrics and washing programmes



Long-lasting active formula



Long-lasting fragrance after tumble drying

In the washing machine



Pour the perfume into the fabric conditioner tray before starting the selected washing programme:

- 1 cap (5ml) for delicate fragrance
- 2 caps (10ml) for intense fragrance



Initial hints of pine needles explode into the floral scent of cyclamen. The floral heart has notes of lavender, carnation and geranium. The woody finish is intense thanks to the cedar wood and a vibrant combination of coumarin and amber.

LPL1001B 35602035 EAN 8016361971080 100ml



The intense and vibrant note of neroli and orange introduces an intensely floral body that combines the hints of May rose to velvety, green tones of geranium. The woody finish is thanks to the hints of boisée and sweetened by the warmth of vanilla and coumarin. Its persistence is thanks to the white moss.

LPL1002M 35602036 EAN 8016361971097 100ml



Fresh and sparkling hints of sweet orange combine with the inebriating fragrance hints of talcum which comes through from beginning to end. A fragrance that gives off explosive energy. The iris florentina and coumarin give warmth and persistence to the combination.

LPL1003F 35602037 EAN 8016361971103 100ml

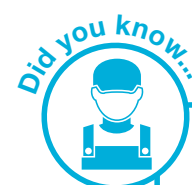

- The fragrance is made up of 100% concentrated perfume which ensures greater intensity compared to other laundry perfumes on the market with noticeably lower perfume percentages (from 5 to 30%).
- It binds to fibers and fabrics perfectly during the final rinse cycle, ensuring **long-lasting fragrance**.
- Since it is not water soluble, the fragrance does not wash away and is reactivated each time it comes into contact with moisture. This makes it perfect also for sportswear.



The intense fragrances give a touch of style to your laundry.

The perfume covers that of the fabric conditioner and remains even after tumble drying.

Active, long-lasting fragrance.



POWERFUL
DETERGENT ACTION

ALL-IN-ONE DETERGENT TABLETS FOR DISHWASHERS

The professional formula guarantees **perfect washing results** every day and is **effective on all the most stubborn kinds** of dirt thanks to its degreasing power. Continuous use of the tablets protects glass and stainless steel and keeps dishes sparkling, preventing surface streaks and stains. The tablets **neutralise bad odours** and release a **fresh lemon fragrance**.



Its effectiveness has been tested on 11 of the most stubborn types of dirt



Extra brightness with no streaks



Water-soluble film

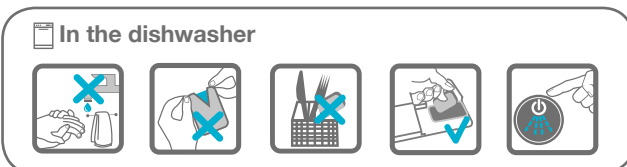

In the dishwasher



MULTI-ACTION

- Detergent
- Degreaser
- Salt action
- Rinse aid
- Protects crystal



Tested on 11 of the most stubborn types of dirt such as tea, red wine and tomato sauce, with better results than more common products sold in supermarkets.

Perfect washing results, even on the most stubborn dirt.



x30
WASHING CYCLES

LDT2030 35602032 EAN 8016361971059 30 TABS x 18g



EXTREME
POWER

DISHWASHING POWDER

The professional formula, enriched with activated oxygen, is effective on all the most stubborn kinds of dirt, even at low temperatures. Guarantees perfect washing results every day and a deep clean for all types of dishes. Neutralises bad odours, releasing a fresh **lemon fragrance**.



Professional formulation with activated oxygen



Its effectiveness has been tested on 11 of the most stubborn types of dirt



Perfect washing results

x50
WASHING CYCLES

LDP2001 35602033 EAN 8016361971066 1Kg



RINSE AID FOR DISHWASHERS

Ensures **extra shine** for glasses and dishes. Protects from stains and streaks and helps to dry faster.



Extra shine



Protects from stains and streaks



Helps to dry faster



In the dishwasher

x160
WASHING CYCLES

LDR2001 35602034 EAN 8016361971073 500ml



Essential oil
LEMON

Essential oil
ORANGE

DISHWASHER DEODORISER

Releases a pleasant citrus fragrance in every wash, thanks to EVA, a non-toxic, thermoplastic material soaked in **essential oils**.

Two **long-lasting and natural fragrances**: lime and blood orange. Thanks to the practical hook, it is easy to install directly onto the top rack of the dishwasher. Effective up to 100 washes.



Removes bad odours



Citrus essential oils



Long-lasting fragrance

The essential oils release a pleasant fragrance without contaminating the dishes.



2x50
100 CYCLES

CPO2002 35601775 EAN 8016361935273



X4

DISHWASHER WASH & CARE KIT

The kit includes **30 ALL-IN-ONE detergent tablets** and **500ml of Rinse aid** to guarantee perfect washing results, even on the most stubborn dirt, giving dishes and plates extra shine. The **2 deodorisers** provide a pleasant fragrance. The **monthly 3-in-1 descaling powder treatment** protects from limescale, reduces energy consumption and optimises washing results.

Choose the kit to save money.



Perfect washing results and extra brightness



Removes bad odours



Removes limescale

LDT2040-K 35602106 EAN 8016361975781



SAVES SPACE

Stacking your dryer above the washing machine is the **ideal solution for saving useful space in the home.**

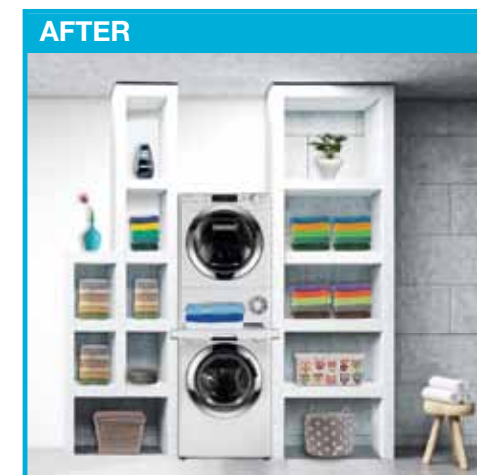
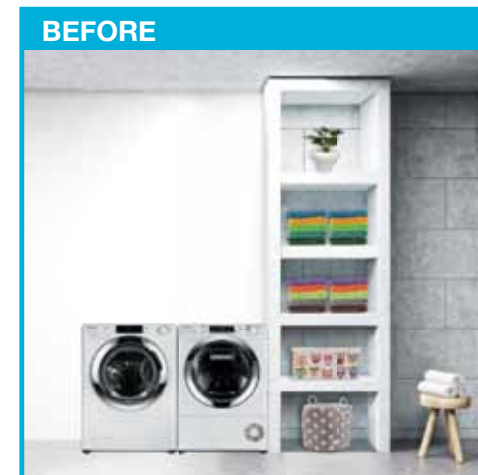

MAXIMUM SAFETY

The kit includes a **safety strip** and **wall mounting kit** to guarantee maximum safety and stability even during the fastest spin cycles.



UNIVERSAL STACKING KIT WITH SLIDING SHELF

Thanks to the **securing strip and wall mount**, the universal stacking kit allows for safe and perfectly stable placement of your dryer above the washing machine, saving useful space in the home. The practical sliding shelf, with **safe stop and anti-tipping system**, holds up to 12kg and makes loading and unloading easier. It is also handy for folding laundry as you empty the dryer. The kit is **suitable to all standard-size appliances** (from 47cm to 62cm of depth) even with rounded front. It is a universal solution that allows to stack appliances from various manufacturers.



Quick and easy to install



Suitable for all standard-size appliances, even with rounded front



Safe, durable and stable even during spin cycles

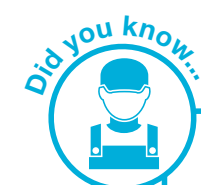

Did you know...

- Fast spinning cycles require the dryer to be positioned in a perfectly secure and stable way above the washing machine.
- The safety strip together with the wall mount are the ideal solution that allows to install the two appliances on top of the other, **without having to drill a hole** into the top of the washing machine.



Just for you

Extremely stable and safe.

Quick and easy installation. The sliding shelf is useful when loading and unloading laundry.

The sliding shelf is useful for folding laundry as you empty the dryer.



STACKING KIT FOR WASHING MACHINES AND DRYERS

Allows to stack the dryer on top of washing machines with a standard depth, allowing you to safely save space in the home.



Quick and easy to install



Stability and safety guaranteed



Ideal for standard appliances



Compatible only with dryers:

- 58 cm DEPTH
- Baumatic ZEROWATT

Can be mounted on all washing machines of any brand

- 47-60 cm DEPTH

WSK1101 35601864 EAN 8016361946705



CONDENSATION PIPE FOR DRYER

Elastic PVC hose for hot air at low pressure. Fire resistant: self-extinguishing UL94-HV class. Thermal resistance: operating temperature ranges between -5°C and +80°C.



WHV1101 35601819 EAN 8016361945425



WHV1102 35601820 EAN 8016361945432



STACKING KIT FOR SLIM WASHING MACHINES AND DRYERS

Allows to stack the dryer on top of slim-depth washing machines, allowing you to safely save space in the home.



Quick and easy to install



Stability and safety guaranteed



Suitable for SLIM appliances



Compatible only with SLIM dryers:

- 46 cm DEPTH
- Baumatic ZEROWATT

Can be mounted on all SLIM washing machines of any brand

- 40-47 cm DEPTH

WSK1102 35601985 EAN 8016361960510



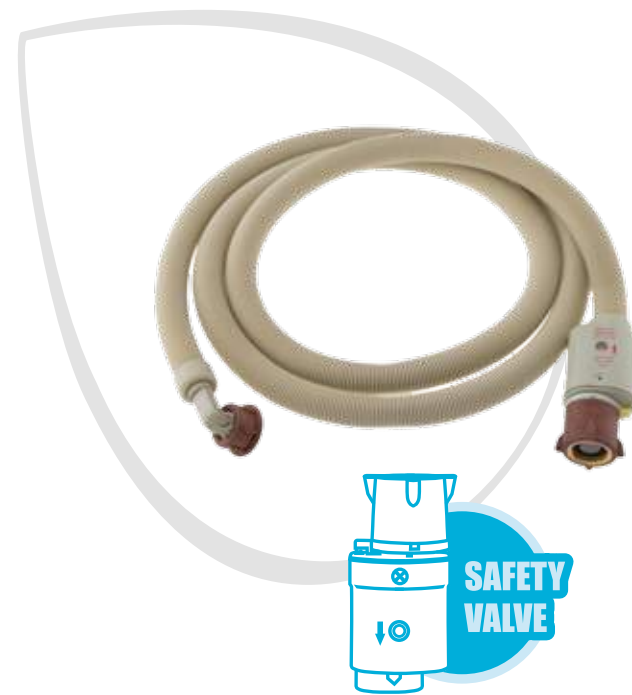

INLET HOSE WITH AQUASTOP SAFETY

The inlet hose with **AQUASTOP** prevents potential flooding of the home due to the water inlet hose breaking. In the event of leaks, a sheath directs the water to a mechanical valve that stops inflow. Any malfunctions are indicated with a red light on the valve.

Certifications: WRAS, VDE, IMQ, EN61770
 Burst pressure: 60 bar
 Hose operating pressure: 20 bar
 Valve operating pressure 10 bar
 Running temperature: max. 93°C

With a 3/4" (EU) ring with anti-loose device, guarantees it is safely secured to the tap.

Attachment: 180°-90° Straight/Curved (S/C)



WHI1051S	35601833	EAN 8016361945562	D/C 1,5m
WHI1052S	35601834	EAN 8016361945579	D/C 2,5m
WHI1053S	35601835	EAN 8016361945586	D/C 3m

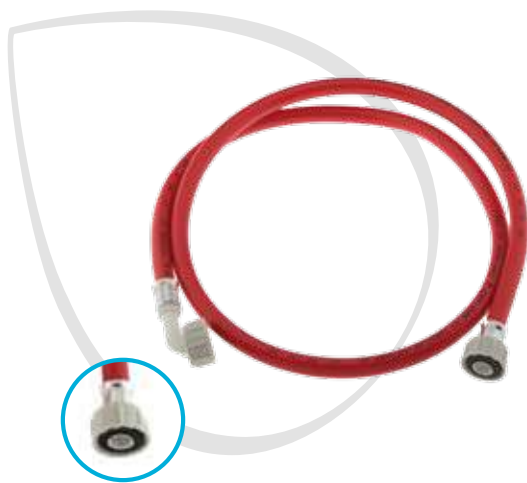

HOT WATER INLET HOSE

Hose for connection to water mains. Designed for hot water under pressure for washing machines and dishwashers.

Burst pressure: 45 bar
 Hose operating pressure: 10 bar
 Running temperature: max. 90°C

A 3/4" (EU) ring guarantees it is safely secured to the tap.

Attachment: 180°-90° Straight/Curved (S/C)
 Attachment: 180°-180° Straight/Straight (S/S)

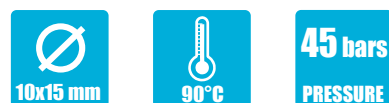

WHI1011R	35601823	EAN 8016361945463	D/C 1,5m	WHI1051R	35601825	EAN 8016361945487	D/D 1,5m
WHI1012R	35601824	EAN 8016361945470	D/C 2,5m	WHI1052R	35601826	EAN 8016361945494	D/D 2,5m



COLD WATER INLET HOSE

Hose for connection to water mains. Designed for cold water under pressure for washing machines and dishwashers.

Certifications: WRAS
 Burst pressure: 60 bar
 Hose operating pressure: 20 bar
 Running temperature: 25°C

A 3/4" (EU) ring guarantees it is safely secured to the tap.

Attachment: 180°-90° Straight/Curved (S/C)



WHI1051W	35601821	EAN 8016361945449	D/C 1,5m
WHI1052W	35601822	EAN 8016361945456	D/C 2,5m



COLD WATER INLET HOSE

Hose for connection to water mains. Designed for cold water under pressure for washing machines and dishwashers.

Burst pressure: 60 bar
 Hose operating pressure: 20 bar
 Running temperature: 25°C

A 3/4" (EU) ring guarantees it is safely secured to the tap.

Attachment: 180°-90° Straight/Curved (S/C)
 Attachment: 180°-180° Straight/Straight (S/S)



WHI1051	35601827	EAN 8016361945500	D/C 1,5m	WHI1001	35601830	EAN 8016361945531	D/D 1,5m
WHI1052	35601828	EAN 8016361945517	D/C 2,5m	WHI1002	35601831	EAN 8016361945548	D/D 2,5m
WHI1053	35601829	EAN 8016361945524	D/C 3,5m	WHI1003	35601832	EAN 8016361945555	D/D 3,5m



Y CONNECTOR FOR INLET HOSES WITH ROTATING JOINT

With 3/4" GAS ring to safely secure it to the tap.



WHA1001	35601858	EAN 8016361945814
---------	----------	-------------------



OUTLET HOSE 19-21 mm

Hose designed in special thermoplastic polymers for draining water, detergents and condensation at low pressure. High flexibility and resistance to compression.

Running temperature: > 90°C
Attachment: 180°-180° Straight/Straight (S/S) - 19-21 mm
Attachment: 180°-90° Straight/Curved (S/C) - 19-21 mm
Diameter: 19x24 mm



hook included

WHD1001*	35601839	EAN 8016361945623	D/D 1,5m	WHD1007	35601844	EAN 8016361945678	D/C 1,5m
WHD1002*	35601838	EAN 8016361945616	D/D 2,5m	WHD1008	35601845	EAN 8016361945685	D/C 2,5m
WHD1003	35601840	EAN 8016361945630	D/D 3,5m	WHD1009	35601846	EAN 8016361945692	D/C 3,5m

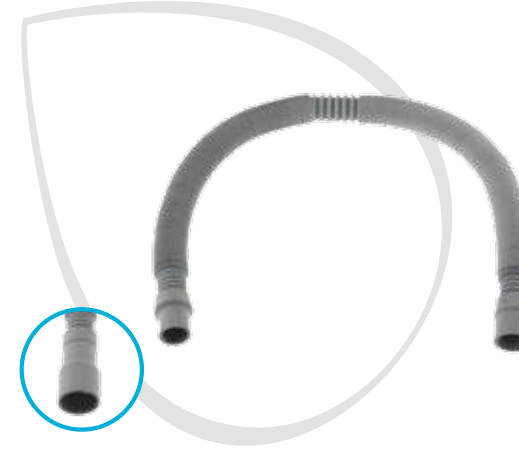

EXTENDABLE OUTLET HOSE

Extendable hose designed in special thermoplastic polymers with adjustable length and curvature. Flexible and adaptable to all installations.

Running temperature: > 90°C
Attachment: 180°-180° Straight/Straight (S/S) - 19-21 mm
Attachment: 180°-180° Straight/Straight (S/S) - 19-21/28 mm
Attachment: 180°-180° Straight/Straight (S/S) - 21/28-21/28 mm
Diameter: 19x29 mm



EXTENDABLE FROM 0,6m TO 2m:

WHD1015E	35601852	EAN 8016361945753	D/D 19-21mm
WHD1013E	35601850	EAN 8016361945739	D/D 19-21/28mm
WHD1017E	35601854	EAN 8016361945777	D/D 21/28-21/28mm

EXTENDABLE FROM 1,2m TO 4m:

WHD1016E	35601853	EAN 8016361945760	D/D 19-21mm
WHD1014E	35601851	EAN 8016361945746	D/D 19-21/28mm
WHD1018E	35601855	EAN 8016361945784	D/D 21/28-21/28mm



OUTLET HOSE 21-21 mm

Hose designed in special thermoplastic polymers for draining water, detergents and condensation at low pressure. High flexibility and resistance to compression.

Running temperature: > 90°C
Attachment: 180°-180° Straight/Straight (S/S) - 21-21 mm
Diameter: 19x24 mm



WHD1004	35601841	EAN 8016361945647	D/D 1,5m
WHD1005	35601842	EAN 8016361945654	D/D 2,5m
WHD1006	35601843	EAN 8016361945661	D/D 3,5m



EXTENSION FOR OUTLET HOSE

Extension hose designed in special thermoplastic polymers. Flexible and adaptable to all installations.

Running temperature: > 90°C
Attachment: 180°-180° Straight/Straight (S/S) - Joint -19 mm
Diameter: 19x24 mm



hook included

WHD1019*	35601856	EAN 8016361945791	D/D 1,5m
WHD1020*	35601857	EAN 8016361945807	D/D 2,5m



OUTLET HOSE 21-21/28 mm

Hose designed in special thermoplastic polymers for draining water, detergents and condensation at low pressure. High flexibility and resistance to compression.

Running temperature: > 90°C
Attachment: 180°-180° Straight/Straight (S/S) - 21-21/28 mm
Diameter: 19x24 mm



hook included

WHD1010*	35601847	EAN 8016361945708	D/D 1,5m
WHD1011*	35601849	EAN 8016361945722	D/D 2,5m
WHD1012*	35601848	EAN 8016361945715	D/D 3,5m



Y CONNECTOR FOR OUTLET HOSES

Universal connector in polypropylene with triple attachment, 20mm in diameter.



WHA1002	35601859	EAN 8016361945821
---------	----------	-------------------



Cooking

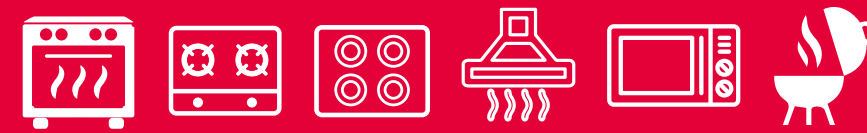

A full range of accessories, filters and professional detergents to keep your cooking surfaces always clean and hygienic.



DEGREASER FOR STAINLESS STEEL SURFACES AND HOODS

Removes oil and stubborn grease preserving your stainless steel surfaces.

- Removes oil and stubborn grease
- Does not scratch
- Does not leave streaks

CSL3801 35601784 EAN 8016361935365 500ml



POLISHING CREAM FOR STAINLESS STEEL SURFACES

A specific cream to remove marks and fingerprints, leaving stainless steel surfaces shiny and bright.

- Removes fingerprints
- Leaves surfaces shiny and bright
- Protects surfaces

CSC3801 35601785 EAN 8016361935372 500ml



DEGREASER FOR INDUCTION & VITROCERAMIC HOBS

Works quickly and effectively against dirt, grime, grease and stains. Does not leave streaks.

- Rapid action
- Removes grease and stains
- Does not leave streaks

CSL3805 35601786 EAN 8016361935389 500ml



MULTI-SURFACE DEGREASER

Degreases, hygienically cleans and removes difficult stains from washable surfaces such as plastic, laminate, glass, mirrors, screens and metal surfaces. Also effective against ink stains.

- Rapid action
- Sanitises
- Degreases and removes difficult stains

CSL3000 35601778 EAN 8016361935303 500ml



DEGREASER FOR OVENS, GRILLS AND BARBECUES

Professional formulation to quickly remove dirty deposits and grease.

- Removes burnt-on grease
- Effective also at room temperature
- Optimised performance

CSL3701 35601779 EAN 8016361935310 500ml



DEGREASER FOR MICROWAVE OVENS

A product created to specifically clean the inside of microwave ovens, without damaging internal parts.

- Removes food deposits
- Degreases and eliminates bad smells
- Does not damage internal parts

CSL8001 35601782 EAN 8016361935341 500ml



DEGREASING AND POLISHING KIT FOR STAINLESS STEEL

The kit includes 1 professional degreaser and 1 professional polishing cream. The kit also includes a microfiber cloth, specifically for cleaning all surfaces, even the most delicate.

Choose the kit to save money.

- Removes stubborn grease and fingerprints
- Makes shiny and bright
- Protects surfaces

CSL3802-K 35602107 EAN 8016361975798





To ensure the longevity and performance of your hood, the first step is keeping the filter system in excellent condition. To identify the filter required, we must distinguish between an **internal recirculating hood** and an **external extraction hood**.

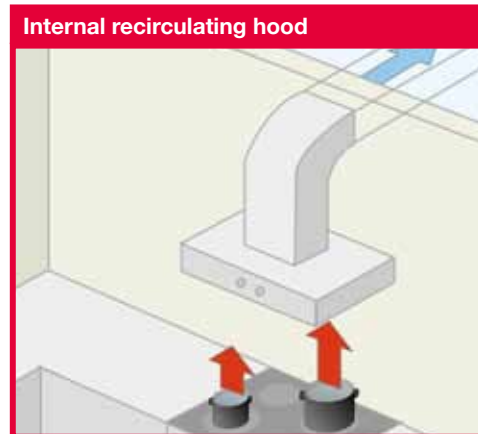

Recommended filters:
 - anti-odour activated carbon filter
 - cut-to-fit anti-grease filter



Recommended filters:
 - cut-to-fit anti-grease filter

- The **anti-grease filter** protects the hood by capturing grease particles. It is universal and can be cut to fit. It is recommended to replace the filter every 3 months.
- The **anti-odour activated carbon filter** captures the odour particles from the air and traps them. It is recommended to replace the filter every 3 months.



Small and simple precautions will help you keep your hood hygienic and running efficiently. The wide professional range of anti-grease and anti-odour hood filters has been designed to ensure best filtration and extraction in any type of hood.

Compatibility table



COMPATIBILITY	KFC6901	KFC6902	KFC6903	KFC6904	KFC6905	KFC6906	KFC6907	KFC6908	KFC6909	KFC6910	KFC6911	KFC6912	KFC6913	KFC6914	KFC6915	KFC6916	KFC6917	KFC6918	KFC6919	KFC6920	Cut-to-fit
CANDY	x	x			x	x	x		x			x		x			x	x			
HOOVER		x				x	x		x			x	x						x		x
ROSIERES	x	x			x	x	x		x	x	x	x	x					x	x	x	x
ZEROWATT																			x		
BAUMATIC	x																			x	
IBERNA	x								x												
ACEC			x																		
AEG											x										
AIRLUX	x	x					x			x											
AMANA									x				x								
ARCELIK					x																
ARISTON	x		x									x	x	x	x						
ARTHUR MARTIN	x		x		x		x			x	x	x					x		x		
BAUKNECHT	x		x	x	x	x	x	x	x		x	x	x		x	x					x
BELLING		x																			x
BEST										x											
BOSCH	x																				x
BOSSMATIC				x																	
BRANDT	x						x	x	x	x										x	
BROAN										x											
BRUYNZEEL												x				x					
CLIMADIFF	x																				x
DE DIETRICH	x		x					x		x											
ELECTROLUX	x		x	x	x		x	x		x	x	x									x
ELICA					x	x	x	x		x	x		x								x
FAGOR						x		x		x											
FAR																					x
FAURE			x				x	x				x					x	x			
FIRENZI				x		x															
IKEA FROM WHIRPOOL													x					x			x
FORS										x											
FUNCTIONICA						x															
GLEM										x											
GORENJE		x		x				x													
HOTPOINT				x			x		x			x	x	x	x						
HOTPOINT ARISTON	x		x			x	x	x				x	x	x	x						x
HUDSON										x											
IGNIS	x			x	x	x	x	x	x		x	x	x				x	x			x
IKEA				x	x	x	x	x	x		x	x									x
INDESIT	x		x		x	x	x	x	x			x									x
INTEGRA					x												x				
KAISER										x											
KITCHEN AID															x						x
KÖNIG										x											
LADEN												x				x					
LISTO		x																			
MALLORCA										x											
MANUEST										x											
MAYTAG									x				x								
NEFF	x			x																	x
NEUTRAL						x				x											
NEUTRAL (KINGSWOOD)										x											
POLAR									x												
PRIVILEG					x		x					x					x				
PROLINE ET THOMSON															x						
RADIOLA						x															
ROBLIN				x																	
SAMSUNG		x																			
SAUTER				x						x		x									x
SCHOLTES	x			x	x			x			x	x	x		x		x				x
SIEMENS	x					x					x										x
SMEG	x											x									
THERMEX								x													
THERMOR	x																				
THOMSON																					
VENMAR										x											
WESTELLUX										x											
WHIRPOOL	x		x	x	x	x	x	x	x		x	x	x			x	x			x	x
ZANUSSI				x																	x

UNIVERSAL



COMPATIBLE ACTIVATED CARBON ANTI-ODOUR FILTERS

A wide professional range of hood filters that are compatible with all major brands on the market, selected to provide best filtration and extraction.

The filter is made up of **very high quality AC90 carbon** with odour and vapour absorption strength that is **4 times more effective** than traditional carbon filters (AC20). Since they are **self-extinguishing**, they are completely safe to use and comply with the UL94;V-2 standard. They come with a **saturation indicator** that changes colour to indicate when filter replacement is due. Practical and easy to install. It is recommended to replace the filter every **3 months**.



Anti-odour



Maximum absorption



With saturation indicator

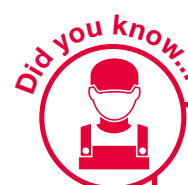

- Filter maintenance affects a hood's **efficiency, longevity and noise levels**.
- Anti-odour activated carbon filters **effectively prevent bad odours from forming**.



The air recirculated into the home in healthier and less "greasy".

Bad odours are reduced to a minimum.

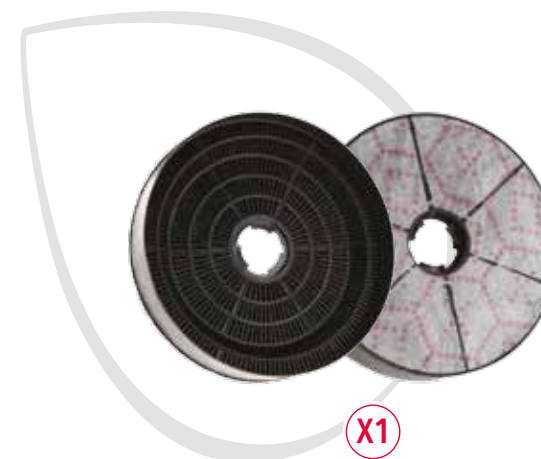

X1

KFC6918 (CP178) 35602061 EAN 8016361972940
Ø170x35mm; 180gr - Type 178

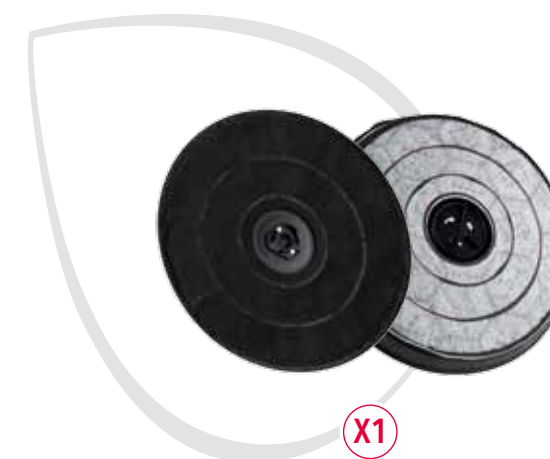

X1

KFC6903 (CP233) 35602046 EAN 8016361971196
Ø228x30mm; 200gr - Type 233



X1

KFC6901 (CP210) 35602044 EAN 8016361971172
Ø210x35mm; 340gr - Type 210

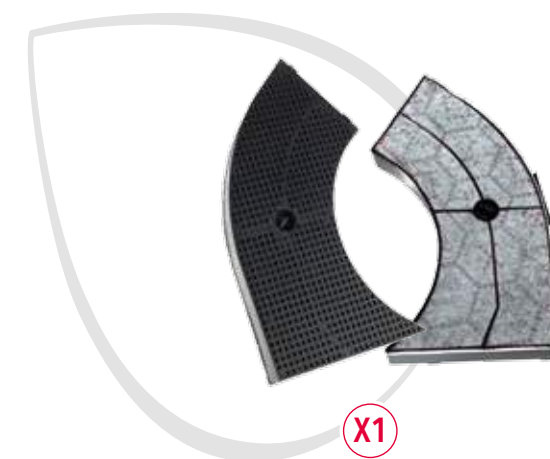

X1

KFC6906 (CP010) 35602049 EAN 8016361971226
240x225x25mm; 250gr - Type 010



X1

KFC6902 (CP180) 35602045 EAN 8016361971189
Ø180x40mm; 180gr - Type 180

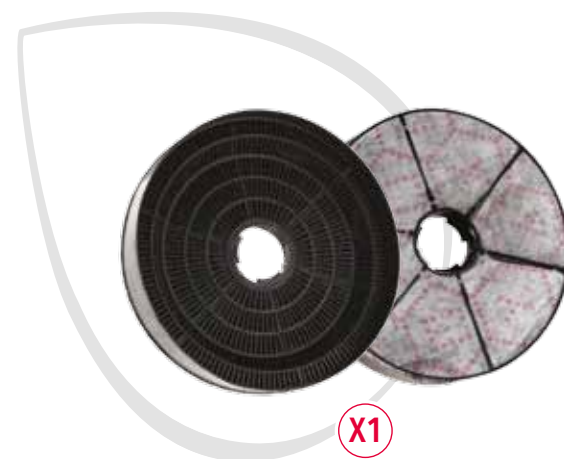

X1

KFC6919 (CP185) 35602062 EAN 8016361972957
Ø180x40mm; 180gr - Type 185



X1

KFC6905 (CP030) 35602048 EAN 8016361971219
Ø230x35mm; 330gr - Type 030

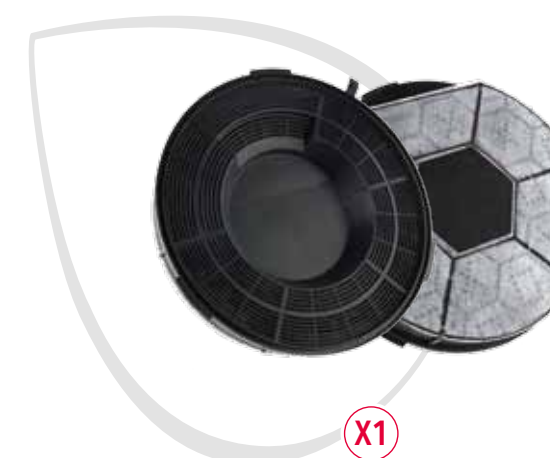

X1

KFC6904 (CP028) 35602047 EAN 8016361971202
Ø240x32mm; 410gr - Type 028

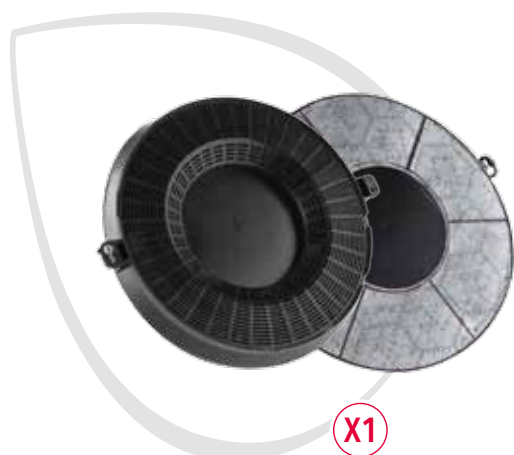

X1

KFC6907 (CP048) 35602050 EAN 8016361971233
 Ø233x33mm; 300gr - Type 048

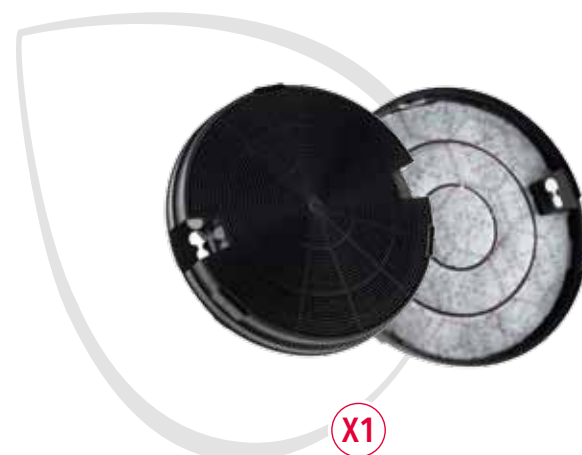

X1

KFC6909 (CP029) 35602052 EAN 8016361971257
 Ø193x34mm; 260gr - Type 029

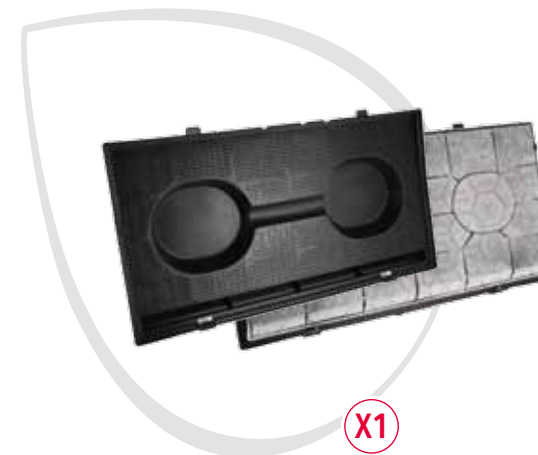

X1

KFC6917 (CP190) 35602060 EAN 8016361972933
 480x250x40mm; 1030gr - Type 190

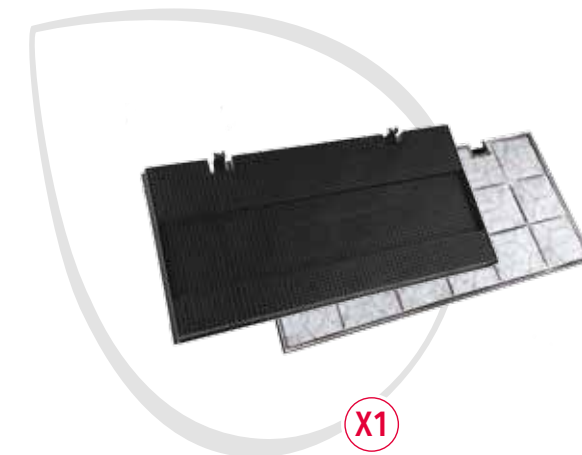

X1

KFC6911 (CP150) 35602054 EAN 8016361971271
 435x217x20mm; 1110gr - Type 150

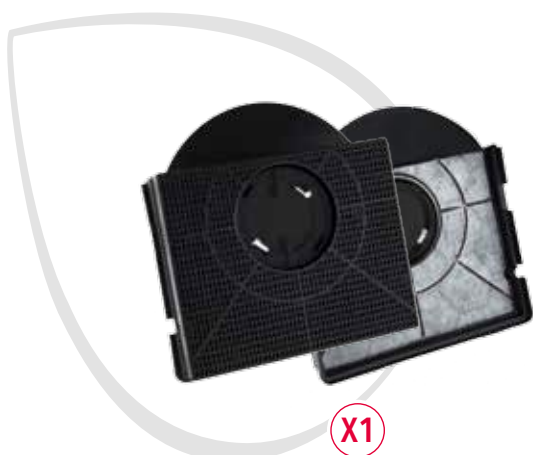

X1

KFC6908 (CP303) 35602051 EAN 8016361971240
 206x170x40mm; 320gr - Type 303

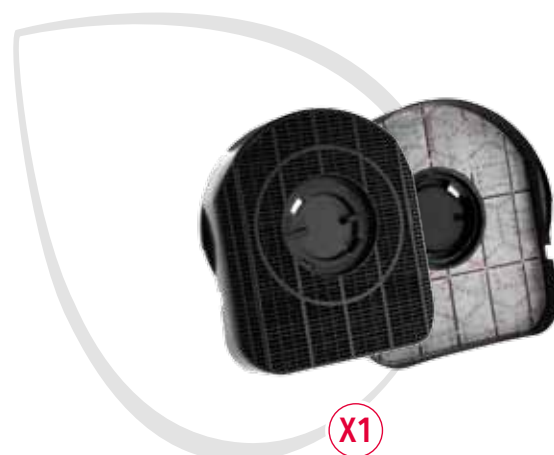

X1

KFC6920 (CP200) 35602063 EAN 8016361972964
 208x180x48mm; 390gr - Type 200

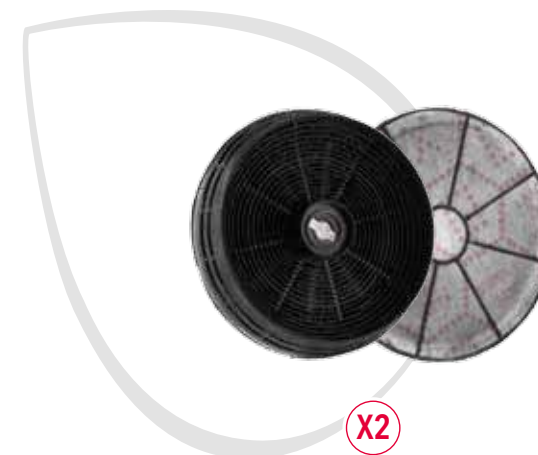

X2

KFC6914 (CP145) 35602057 EAN 8016361971301
 Ø146x30mm; 220gr - Type 145 - 2 filters per pack

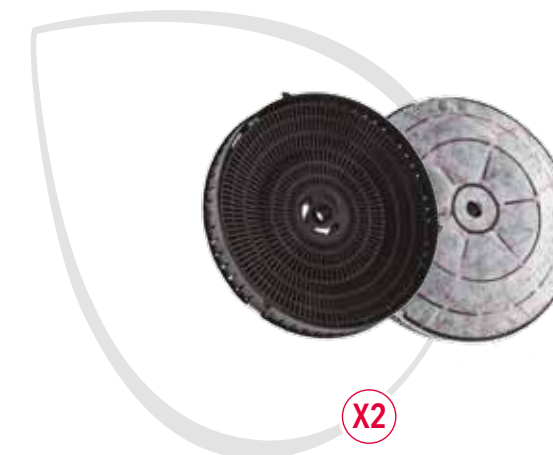

X2

KFC6915 (CP057) 35602058 EAN 8016361971318
 Ø175x45mm; 406gr - Type 057 - 2 filters per pack

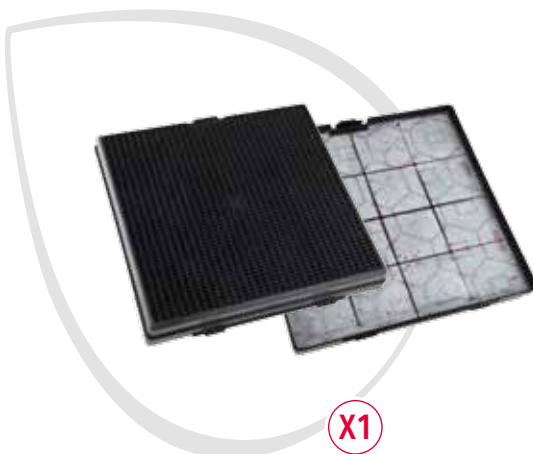

X1

KFC6910 (CP241) 35602053 EAN 8016361971264
 223x228x30mm; 510gr - Type 241

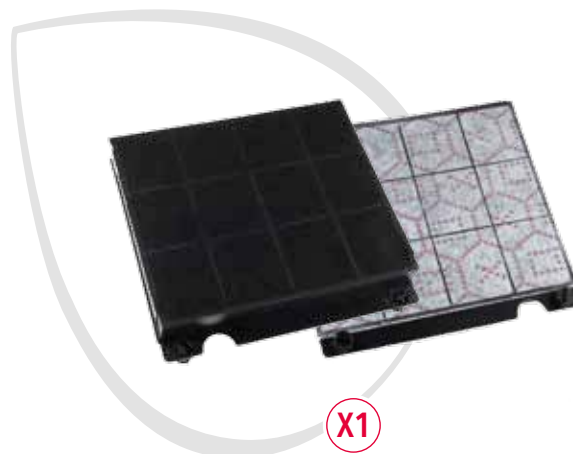

X1

KFC6912 (CPM15) 35602055 EAN 8016361971288
 225x210x30mm; 530gr - Type M15

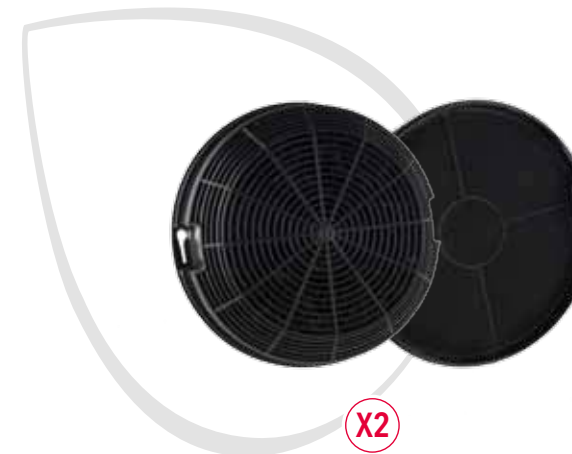

X2

KFC6916 (CP047) 35602059 EAN 8016361971325
 Ø150x50mm; 560gr - Type 047 - 2 filters per pack



WASHABLE ACTIVATED CARBON FILTER
 The filter is made up of **very high quality AC90 carbon** with absorption strength that is **4 times more effective** than traditional carbon filters (AC20). **Washable**, even in dishwashers at high temperature. The filter must be reactivated by drying it in an oven for 10 minutes at 100°C so as to make it **reusable**. Since it is **self-extinguishing**, it is completely safe to use and complies with the UL94;V-2 standard. Practical and easy to install. It is recommended to replace the filter every **3 months**.

- Washable and reusable
- Anti-odour
- Maximum absorption
- Self-extinguishing

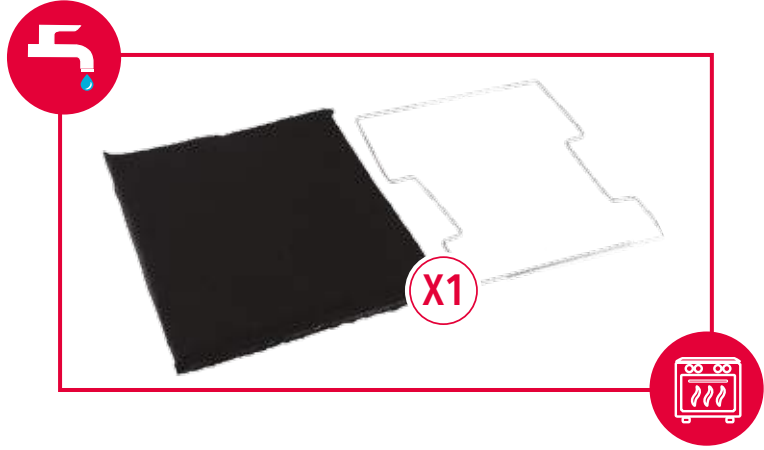

KFC6913 (CP020) 35602056 EAN 8016361971295
 219x182x20mm; 160gr - Type 020

[View all compatible filters on the website](http://www.compatibility.careplusprotect.com)
www.compatibility.careplusprotect.com



UNIVERSAL 2-IN-1 ANTI-GREASE AND ANTI-ODOUR CUT-TO-FIT FILTER

With its double anti-odour and anti-grease function, the filter has very high odour and grease absorption power while extracting vapour and cooking fumes.

- Universal and cut-to-fit
- Anti-grease and anti-odour
- Self-extinguishing

KFU6903 35602042 EAN 8016361971158 47X57 cm



UNIVERSAL ANTI-ODOUR CUT-TO-FIT FILTER

The anti-odour activated carbon filter captures grease molecules while extracting vapour and cooking fumes.

- Universal and cut-to-fit
- Anti-odour
- Self-extinguishing

KFU6904 35602043 EAN 8016361971165 47X97 cm



ANTI-GREASE CUT-TO-FIT FILTER WITH SATURATION INDICATOR

The filter captures grease molecules while extracting vapour and cooking fumes. It comes with a saturation indicator that changes colour to indicate when filter replacement is due.

- Universal and cut-to-fit
- Anti-grease
- With saturation indicator
- Self-extinguishing

KFU6902 35602041 EAN 8016361971141 47X97 cm



ANTI-GREASE CUT-TO-FIT FILTER

The filter captures grease molecules while extracting vapour and cooking fumes.

- Universal and cut-to-fit
- Anti-grease
- Self-extinguishing

KFU6901 35602040 EAN 8016361971134 47X97 cm



UNIVERSAL ADJUSTABLE BAKING TRAY

Adjustable baking tray (37cm to 52cm) for maximum versatility in the kitchen. Made in Hi-Top steel with a double layer of Skandia Xtreme Plus coating, to ensure perfect baking and non-stick results. BPA, PFOA and heavy metal free.

Dimensions (LxWxH): 37/52x33x3,5 cm



Perfect baking results



Double layer of non-stick coating



Top quality steel for perfect conductivity

Just for you



Can be used in ovens and mini ovens.

Split in two, it is easy to wash in the dishwasher.

It is perfectly non-stick and ensures even baking.

Suitable for sweet and savoury recipes.

KAT3701 35601999 EAN 8016361963702

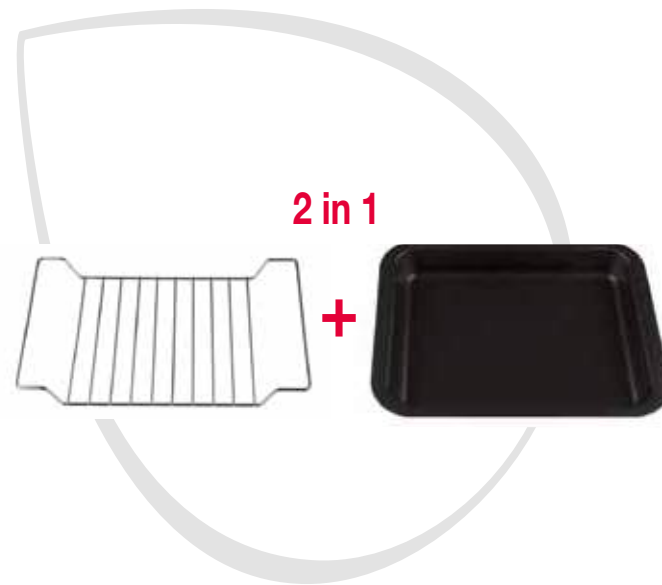

2-IN-1 ROASTING PAN AND GRID

Together with the grid, it allows for cooking in a light and healthy way without compromising cooking results. Made in Hi-Top steel with a double layer of Skandia Xtreme Plus coating, to ensure perfect baking and non-stick results.

BPA, PFOA and heavy metal free.

Dimensions (LxWxH): 32x24x6 cm



Perfect baking results



Double layer of non-stick coating



Oil and fat free for light and healthy cooking

Just for you



Can be used in a number of ways, either combined or individually.

Perfectly non-stick and easy to clean.

The grid is ideal for low-fat cooking because fats drip into the tray.

KAG3701 35602000 EAN 8016361963719





Cooling



Hygienically cleans, de-ices and absorbs odours to best preserve food.



RAPID ACTION HYGIENIC CLEANER

Cleans internal surfaces, making them hygienic, and eliminates unpleasant odours thanks to a pleasant citrus fragrance. Effective on moulds, it prevents bacteria from spreading ensuring food is preserved well.



Eliminates and prevents bad odours



Removes stains and mould



Citrus essential oils

CSL4001 35601783 EAN 8016361935358 500ml



UNIVERSAL ODOUR ABSORBER FOR FRIDGES

A naturally-derived, solid gel that removes unpleasant smells in the fridge, preserving the freshness and flavour of the food.

- Long lasting: 60 days
- Replacement line



Eliminates bad smells and preserves the flavour of the food



Cap with temperature indicator and replacement line



Natural solid gel, allergen free



FAD4001 35602001 EAN 8016361963726



RAPID ACTION DE-ICER

Improves the performance of appliances – fridge and freezer – and reduces energy consumption related to ice deposits. Defrosts quickly and effectively. Recommended also for use on car windscreens.



Melts ice quickly



Prevents ice from forming



Effective also on car windscreens

CSL7001 35601780 EAN 8016361935327 500ml



Vacuuming



Hygienizer, deodorant and universal accessories for vacuum cleaners.



PERFUMED GRANULES FOR VACUUM CLEANERS

100% natural and developed for vacuuming. Effectively remove bad odours and release a pleasant lavender aroma while vacuuming.



Eliminates odours



Lavender fragrance



Long-lasting fragrance



100% natural granules



CPO9004 35601788 EAN 8016361935402 4 sachets x 15g



RAPID ACTION HYGIENIZER

Hygienically deep cleans dust collection bins, protecting from dust mites and allergens. Also ideal for waste bins. Releases a pleasant menthol fragrance.



Hygienically cleans and removes bad odours



Menthol fragrance



Also ideal for waste bins

CSL9001/1 35602118 EAN 8016361935396 500ml



UNIVERSAL CARPET & FLOOR NOZZLE

Universal nozzle for all floor types with flexible neck and adjustable collar (Ø30-38mm). Suitable for cleaning hard surfaces, wooden floors and carpets.



Universal adaptor



For all floor types



Flexible neck



VNA9001 35601983 EAN 8016361960497



UNIVERSAL PARQUET NOZZLE

Universal nozzle for parquet floors with flexible neck and adjustable collar (Ø30-38mm) and 2 wheels for easy use on all wooden and hard floor types. The soft brush protects the surface from scratches.



Universal adaptor



Wooden and hard floors



Flexible neck



VNW9001 35601984 EAN 8016361960503



RIGID UNIVERSAL TELESCOPIC TUBE

Stainless steel universal telescopic tube. Makes vacuuming easier, even in hard-to-reach places.



Stainless steel



Universal



Telescopic tube. Length: 560-940 mm

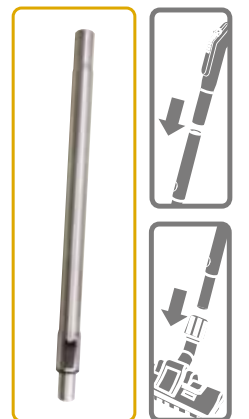

VAR9032 35601981 EAN 8016361960473 Ø32mm
VAR9035 35601982 EAN 8016361960480 Ø35mm



UNIVERSAL GRIP HANDLE

Practical and maneuverable grip handle, with suction regulator. Connects the metal tube to the vacuum cleaner's flexible hose.



With suction regulator



Universal



VAG9032 35601979 EAN 8016361960459 Ø32mm
VAG9035 35601980 EAN 8016361960466 Ø35mm



Ironing



Specific products to keep your ironing system in good condition.



LIQUID DESCALER

Removes limescale, ensuring high performances of your iron. Monthly treatment recommended.



Removes limescale



Optimises performance



Prolongs appliance life



CDL9601 35601776 EAN 8016361935280 500ml



DESCALER IN SINGLE DOSES

Monthly treatment in practical **single doses** to ensure the best performance of your iron, removing limescale and reducing energy consumption.



Removes limescale



Protects internal components



Prolongs appliance life



CDL9612 35601777 EAN 8016361935297 12 phials x 5ml



PROFESSIONAL SOLEPLATE CLEANING STICKS

Removes deposits from your iron soleplate, improving the iron's performance and making ironing easier.



Removes stains and deposits



Makes ironing easier



Improves performance



CDS9602 35601790 EAN 8016361935426 2 sticks



IRON MAINTENANCE KIT

It contains all you need for the maintenance of your iron, improving ironing and preventing stains on clothes. By using a phial of descaler each month and periodically cleaning the soleplate, you will keep your iron running efficiently and ensure a longer service life. Monthly treatments are recommended.

Choose the kit to save money.



Removes limescale, stains and deposits



Protects internal components



Improves performance, making ironing easier

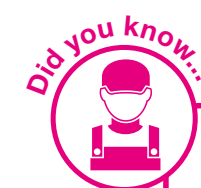

Did you know...

To improve ironing and prevent unpleasant stains on clothes, it is important to care for your iron by using a specific descaler and cleaning the soleplate periodically.



Just for you

A clean iron saves you time and effort.

CDL9606-K 35601791 EAN 8016361935433 kit (1 stick + 6 phials)





Coffee



Liquid and powder descalers for coffee machines and kettles.



DESCALER FOR COFFEE MACHINES AND KETTLES

Monthly treatment in handy single-use sachets to maintain the efficiency of your coffee machine or kettle. It removes limescale, as well as coffee and tea residues to ensure the best aroma from your hot drinks. Monthly treatment is recommended.



Removes limescale



Removes tea and coffee residues



Prolongs appliance life



CDP6006 35601771 EAN 8016361934603 6 sachets x 20g



LIQUID DESCALER FOR KETTLES AND COFFEE MACHINES

Monthly treatment in a liquid solution to maintain the efficiency of your coffee machine or kettle. It removes limescale, as well as coffee and tea residues to ensure the best aroma from your hot drinks. Monthly treatment is recommended.



Removes limescale



Removes coffee residues and oils



Prolongs appliance life



CDL6001 35601772 EAN 8016361935242 500ml

Did you know...



- Deposits and limescale cause the element to overheat, affecting normal operation.
- To maintain the aroma of your hot drinks it is essential to care for coffee machines and kettles with a specific descaler.

Just for you



Reduced consumption.
Aroma and flavour preserved over time.
No burnt coffee aftertaste.



Professional care for your home

The best for your home appliances

www.careplusprotect.com